

24V LED System

Correlated Colour Temperature (CCT) **Tunable White** - 2200K to 5000K

Colour Rendering Index: Ra > 90

Colour Tolerance: MacAdam 3

LED Service Life: 90.000h L80 at 55C

Light Distribution

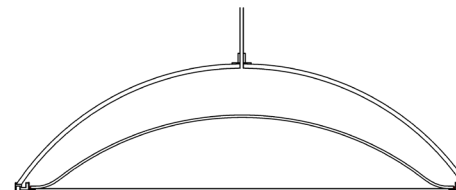

aKupolo | Concave

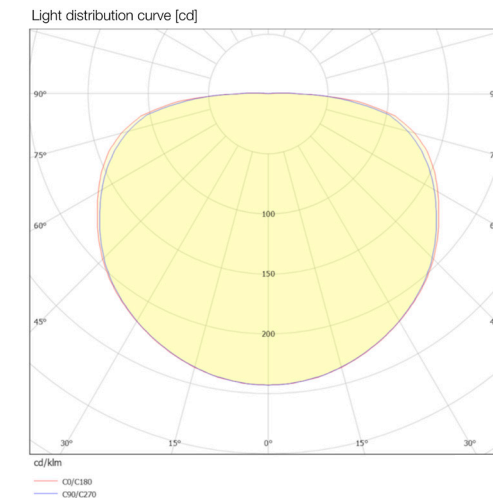

aKupolo | Concave

Dimensions

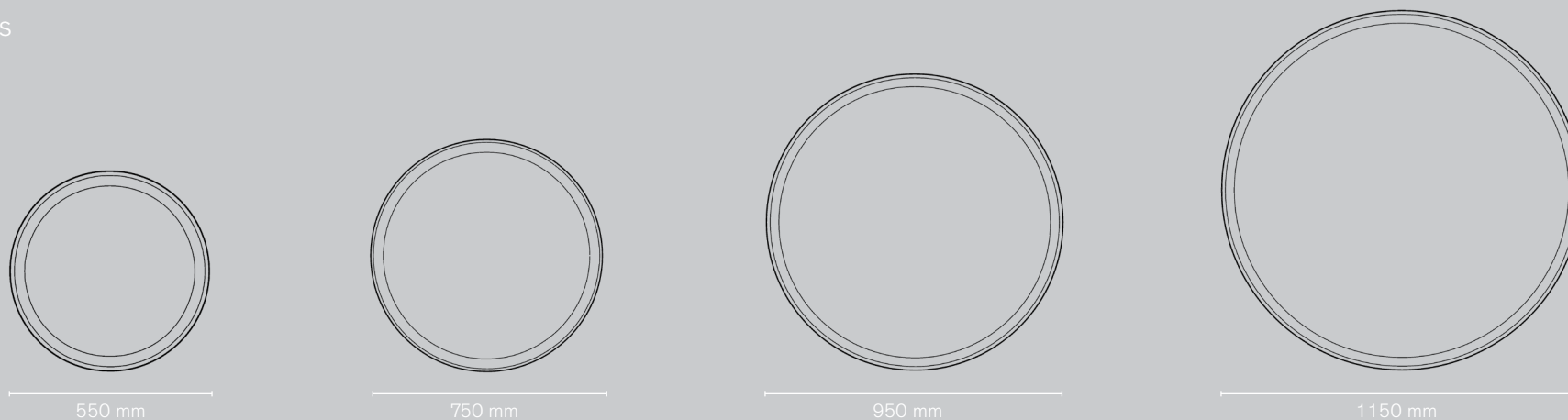

| | Luminaire - Calculated Luminous Flux (lm) | Input Power (W) | Luminaire - Efficacy (lm/W) |
|----------------|---|-----------------|-----------------------------|
| TW2200 - 5000K | Max output (Flux) at 3600K | | TW2200-5000K |
| 550 mm | 4.692lm | 62W | 75lm/W |
| 750 mm | 6.583lm | 87W | 75lm/W |
| 950 mm | 8.475lm | 113W | 75lm/W |
| 1150 mm | 10.369lm | 138W | 75lm/W |

Standby power: 0,5 W

48V LED System

| | |
|-------------------------------------|--|
| Correlated Colour Temperature (CCT) | Tunable White - 2200K to 6500K Standard White - 2700K, 3000K, 4000K, 5000K, 6500K |
| Colour Rendering Index: | Ra > 80 Ra > 90 optional for 2700K, 3000K, 4000K |
| Colour Tolerance: | MacAdam 3 |
| LED Service Life: | L80 (tq 25 °C) = 100.000 h |

Light Distribution

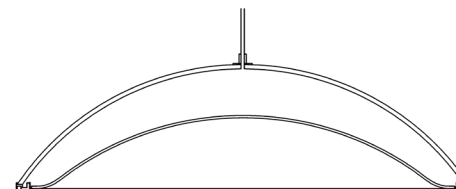

aKupolo | Concave

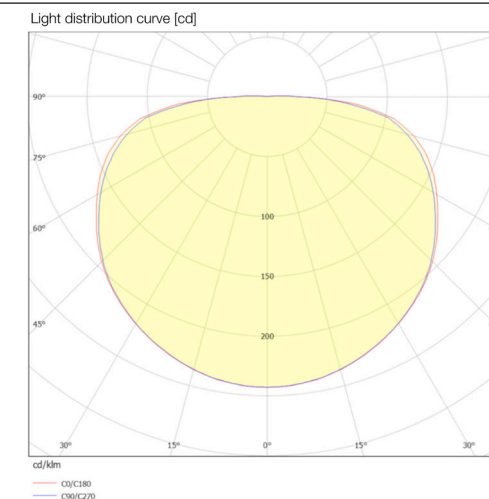

aKupolo | Concave

Dimensions

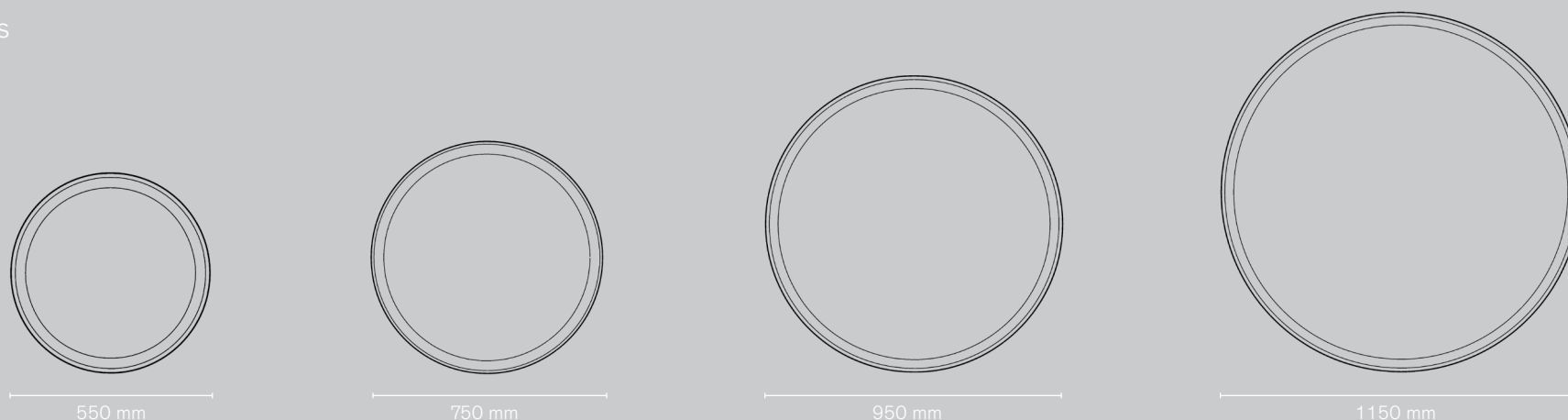

| | Luminaire - Calculated Luminous Flux (lm) | | | | | | Input Power (W) | | Luminaire - Efficacy (lm/W) | | | | | |
|---------|---|----------|----------|----------|----------|----------------------------|-----------------|------|-----------------------------|--------|--------|--------|--------|--------------|
| | 2700K | 3000K | 4000K | 5000K | 6500K | Max output (Flux) at 3720K | SW | TW | 2700K | 3000K | 4000K | 5000K | 6500K | TW2200-6500K |
| 550 mm | 5.184lm | 5.479lm | 5.891lm | 5.891lm | 5.891lm | 8.647lm | 88W | 138W | 59lm/W | 62lm/W | 67lm/W | 67lm/W | 67lm/W | 63lm/W |
| 750 mm | 7.068lm | 7.470lm | 8.032lm | 8.032lm | 8.032lm | 11.789lm | 120W | 181W | 59lm/W | 62lm/W | 67lm/W | 67lm/W | 67lm/W | 65lm/W |
| 950 mm | 8.955lm | 9.464lm | 10.176lm | 10.176lm | 10.176lm | 14.936lm | 152W | 233W | 59lm/W | 62lm/W | 67lm/W | 67lm/W | 67lm/W | 64lm/W |
| 1150 mm | 10.836lm | 11.452lm | 12.314lm | 12.314lm | 12.314lm | 18.074lm | 184W | 284W | 59lm/W | 62lm/W | 67lm/W | 67lm/W | 67lm/W | 64lm/W |

Standby power: 0,5 W

Flux data based on standard dot Light Guide design. **Flux may vary per Etch-Design.**

24V LED System

| | |
|-------------------------------------|---------------------------------------|
| Correlated Colour Temperature (CCT) | Tunable White - 2200K to 5000K |
| Colour Rendering Index: | Ra > 90 |
| Colour Tolerance: | MacAdam 3 |
| LED Service Life: | 90.000h L80 at 55C |

Light Distribution

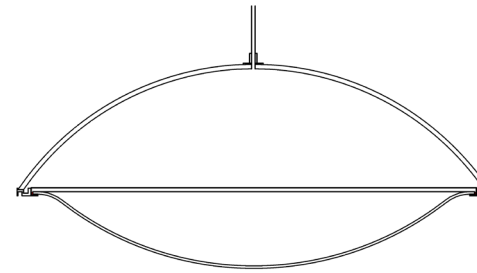

aKupolo | Convex

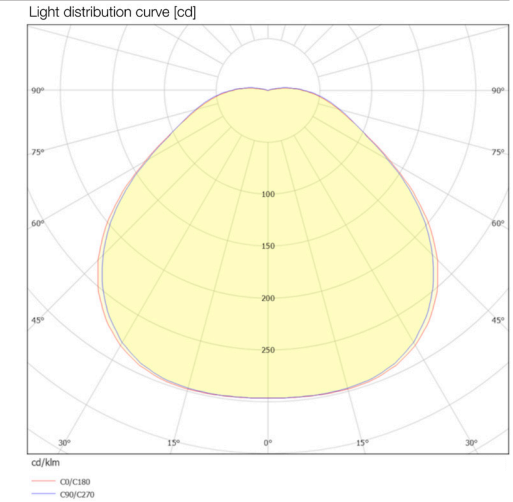

aKupolo | Convex

Dimensions

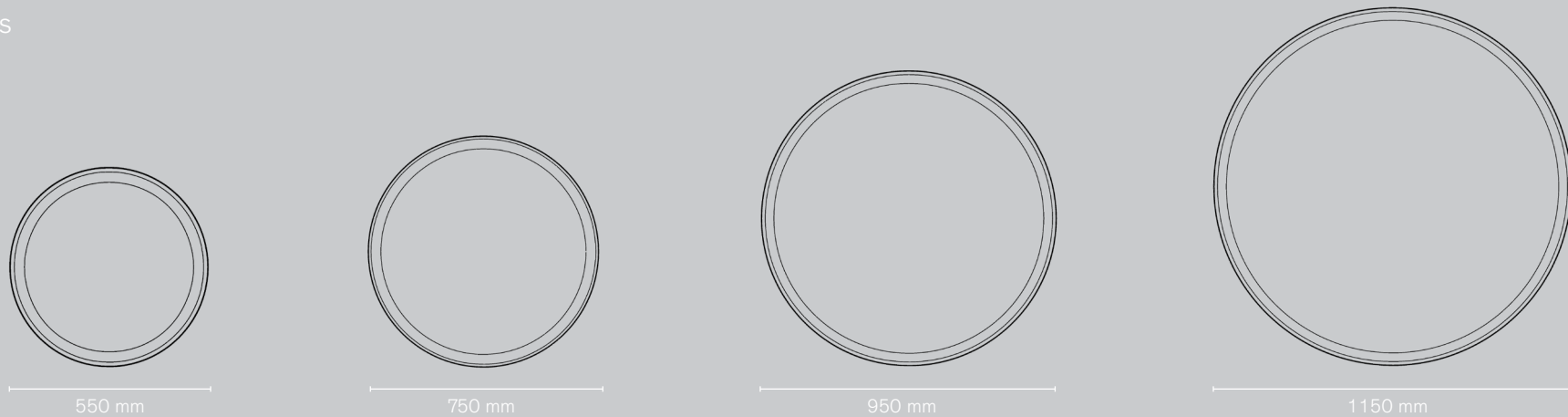

| | Luminaire - Calculated Luminous Flux (lm) | Input Power (W) | Luminaire - Efficacy (lm/W) |
|--------------|---|-----------------|-----------------------------|
| TW2200-5000K | Max output at 3600K | | TW2200-5000K |
| 550 mm | 5.131lm | 62W | 82lm/W |
| 750 mm | 7.199lm | 87W | 82lm/W |
| 950 mm | 9.267lm | 113W | 82lm/W |
| 1150 mm | 11.338lm | 138W | 82lm/W |

Standby power: 0,5 W

48V LED System

| | |
|-------------------------------------|---|
| Correlated Colour Temperature (CCT) | Tunable White - 2200K to 6500K |
| | Standard White - 2700K, 3000K, 4000K, 5000K, 6500K |
| Colour Rendering Index: | Ra > 80 Ra > 90 optional for 2700K, 3000K, 4000K |
| Colour Tolerance: | MacAdam 3 |
| LED Service Life: | L80 (tq 25 °C) = 100.000 h |

Light Distribution

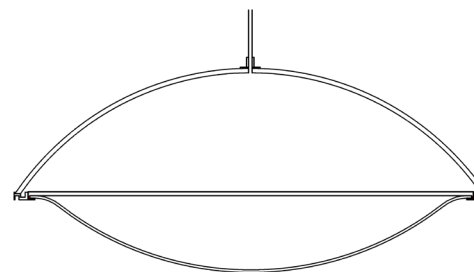

aKupolo | Convex

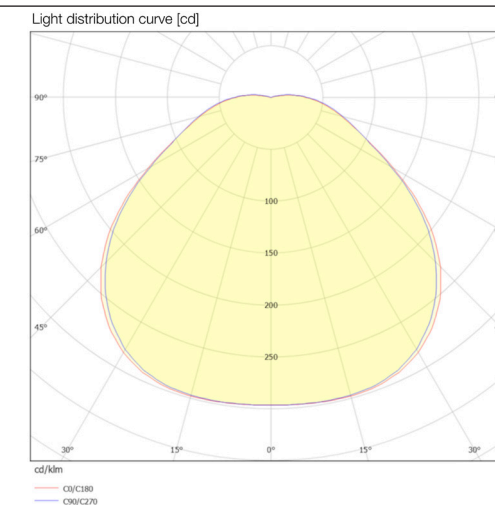

aKupolo | Convex

Dimensions

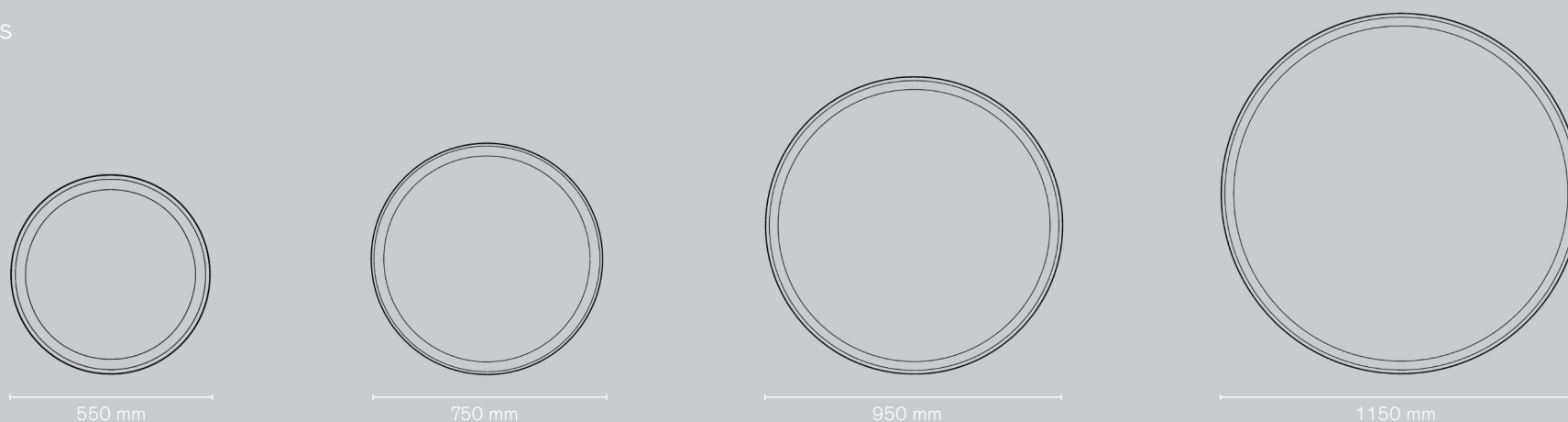

| | Luminaire - Calculated Luminous Flux (lm) | | | | | | Input Power (W) | | Luminaire - Efficacy (lm/W) | | | | | |
|---------|---|----------|----------|----------|----------|----------------------------|-----------------|------|-----------------------------|--------|--------|--------|--------|--------------|
| | 2700K | 3000K | 4000K | 5000K | 6500K | Max output (Flux) at 3720K | SW | TW | 2700K | 3000K | 4000K | 5000K | 6500K | TW2200-6500K |
| 550 mm | 5.655lm | 5.976lm | 6.426lm | 6.426lm | 6.426lm | 9.455lm | 88W | 138W | 64lm/W | 68lm/W | 73lm/W | 73lm/W | 73lm/W | 69lm/W |
| 750 mm | 7.710lm | 8.148lm | 8.762lm | 8.762lm | 8.762lm | 12.891lm | 120SW | 181W | 64lm/W | 68lm/W | 73lm/W | 73lm/W | 73lm/W | 71lm/W |
| 950 mm | 9.769lm | 10.324lm | 11.101lm | 11.101lm | 11.101lm | 16.333lm | 152W | 233W | 64lm/W | 68lm/W | 73lm/W | 73lm/W | 73lm/W | 70lm/W |
| 1150 mm | 11.821lm | 12.492lm | 13.433lm | 13.433lm | 13.433lm | 19.763lm | 184W | 284W | 64lm/W | 68lm/W | 73lm/W | 73lm/W | 73lm/W | 70lm/W |

Standby power: 0,5 W

Flux data based on standard dot Light Guide design. **Flux may vary per Etch-Design.**

24V LED System

Correlated Colour Temperature (CCT) **Tunable White** - 2200K to 5000K

Colour Rendering Index: Ra > 90

Colour Tolerance: MacAdam 3

LED Service Life: 90,000h L80 at 55C

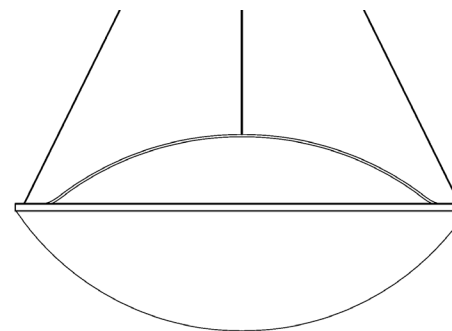

aKupolo | Indirect

Light Distribution

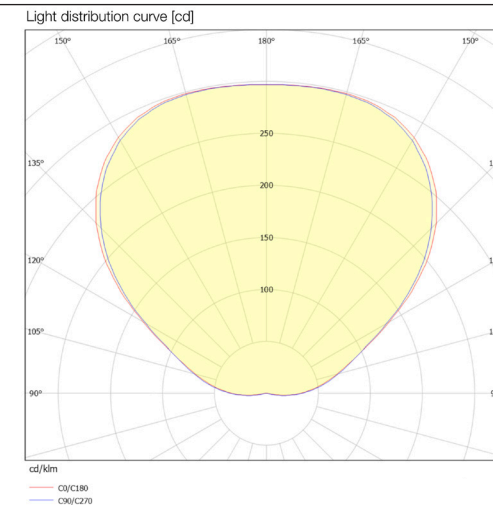

aKupolo | Indirect

Dimensions

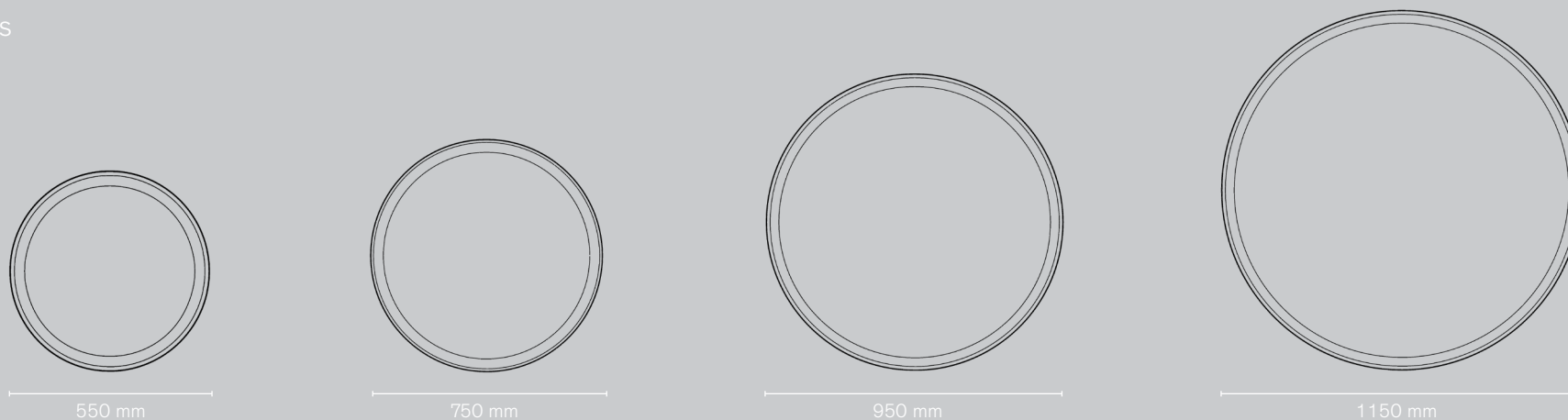

| | Luminaire - Calculated Luminous Flux (lm) | Input Power (W) | Luminaire - Efficacy (lm/W) |
|--------------|---|-----------------|-----------------------------|
| TW2200-5000K | Max output (Flux) at 3600K | | TW2200-5000K |
| 550 mm | 5.131lm | 62W | 82lm/W |
| 750 mm | 7.199lm | 87W | 82lm/W |
| 950 mm | 9.267lm | 113W | 82lm/W |
| 1150 mm | 11.338lm | 138W | 82lm/W |

Standby power: 0,5 W

48V LED System

Correlated Colour Temperature (CCT)

Tunable White - 2200K to 6500K

Standard White - 2700K, 3000K, 4000K, 5000K, 6500K

Colour Rendering Index:

Ra > 80

Ra > 90 optional for 2700K, 3000K, 4000K

Colour Tolerance:

MacAdam 3

LED Service Life:

L80 (tq 25 °C) = 100.000 h

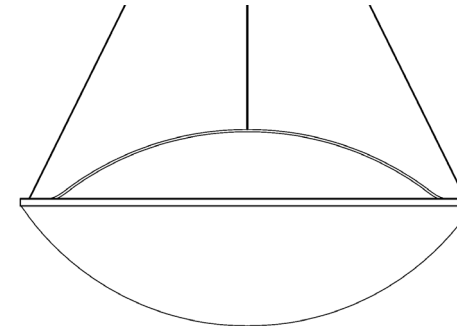

aKupolo | Indirect

Light Distribution

Light distribution curve [cd]

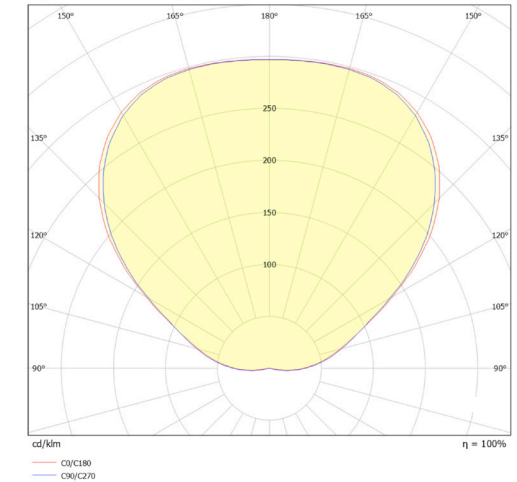

aKupolo | Indirect

Dimensions

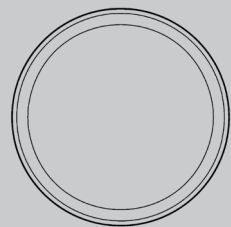

550 mm

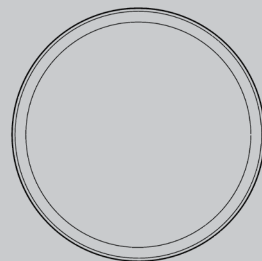

750 mm

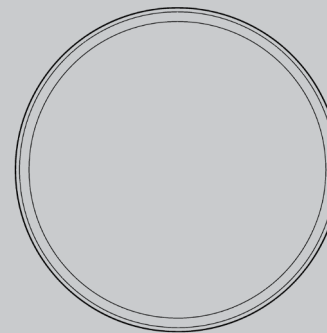

950 mm

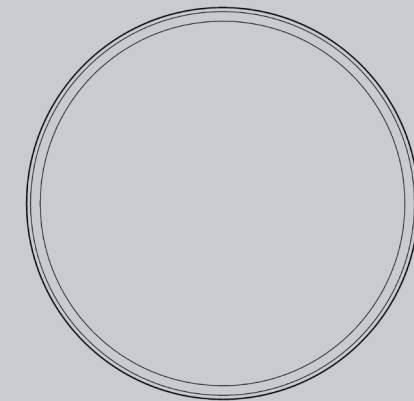

1150 mm

| | Luminaire - Calculated Luminous Flux (lm) | | | | | | Input Power (W) | | Luminaire - Efficacy (lm/W) | | | | | |
|---------|---|----------|----------|----------|----------|----------------------------|-----------------|------|-----------------------------|--------|--------|--------|--------|--------------|
| | 2700K | 3000K | 4000K | 5000K | 6500K | Max output (Flux) at 3720K | SW | TW | 2700K | 3000K | 4000K | 5000K | 6500K | TW2200-6500K |
| 550 mm | 5.655lm | 5.976lm | 6.426lm | 6.426lm | 6.426lm | 9.455lm | 88W | 138W | 64lm/W | 68lm/W | 73lm/W | 73lm/W | 73lm/W | 69lm/W |
| 750 mm | 7.710lm | 8.148lm | 8.762lm | 8.762lm | 8.762lm | 12.891lm | 120W | 181W | 64lm/W | 68lm/W | 73lm/W | 73lm/W | 73lm/W | 71lm/W |
| 950 mm | 9.769lm | 10.324lm | 11.101lm | 11.101lm | 11.101lm | 16.333lm | 152W | 233W | 64lm/W | 68lm/W | 73lm/W | 73lm/W | 73lm/W | 70lm/W |
| 1150 mm | 11.821lm | 12.492lm | 13.433lm | 13.433lm | 13.433lm | 19.763lm | 184W | 284W | 64lm/W | 68lm/W | 73lm/W | 73lm/W | 73lm/W | 70lm/W |

Standby power: 0,5 W

Flux data based on standard dot Light Guide design. **Flux may vary per Etch-Design.**